

Wide input voltage , non-isolated & regulated single output



Patent Protection **RoHS** **CE**

FEATURES

- Efficiency up to 96%
- Operating temperature range: -40°C to +85°C
- Low ripple & noise
- Supporting negative output perfectly
- Short circuit protection and overheat protection
- Subminiature SIP package, meeting requirements of UL94-V0
- Pin-out compatible with LM78XX series
- EN60950 approved

K78xx-500R2 series are high efficiency switching regulators and ideal substitutes of LM78XX series three-terminal linear regulators. The product is featured with high efficiency, low loss, low radiation and no heat sink requirement. They are widely used in industrial control, instrumentation, and electric power applications.

Selection Guide

Certification	Part No.	Input Voltage (VDC)		Output		Efficiency (%/Typ.) (Min. Vin)/ (Max. Vin)	Max. Capacitive Load(μF)
		Nominal	Range	Output Voltage (VDC)	Output Current (mA)		
CE	K7801-500R2	12	4.75-28	1.5	500	77/66	1000
		12	*4.75-25	-1.5	-400	66/64	470
	K78X2-500R2	12	4.75-28	1.8	500	81/69	1000
		12	*4.75-25	-1.8	-400	70/68	470
	K7802-500R2	12	4.75-28	2.5	500	87/76	1000
		12	*4.75-25	-2.5	-400	73/73	470
	K7803-500R2	24	4.75-28	3.3	500	91/81	1000
		12	*4.75-25	-3.3	-400	74/78	470
	K7805-500R2	24	6.5-32	5.0	500	94/86	1000
		12	6.5-27	-5.0	-400	78/83	470
-	K78X5-500R2	24	7-32	5.2	500	94/86	1000
CE	K78X6-500R2	24	8-32	6.5	500	94/87	1000
		12	6.5-25	-6.5	-300	82/84	470
	K7809-500R2	24	11-32	9.0	500	95/91	1000
		12	7.0-23	-9.0	-200	85/86	470
	K7812-500R2	24	15-32	12	500	95/92	1000
		12	7-20	-12	-200	83/87	470
	K7815-500R2	24	18-32	15	500	96/93	1000
		12	7-17	-15	-200	81/87	470

Input Specifications

Item	Operating Conditions	Min.	Typ.	Max.	Unit
No-load Power Consumption	Input voltage range	--	0.12	0.256	W
Reverse Polarity Input		Forbidden			
Input Filter		Capacitor filter			

Output Specifications

Item	Operating Conditions	Min.	Typ.	Max.	Unit
Output Voltage Accuracy	100% load, input voltage range	--	±2	±3	%
Line Regulation	Input voltage range	--	±0.2	±0.4	
Load Regulation	10%-100% load	--	±0.4	±0.6	

Ripple & Noise*	20MHz bandwidth (refer to Fig. 2)	Positive output	--	20	30	mVp-p
		Negative output	--	20	35	
Temperature Drift Coefficient	-40°C to +85°C		--	--	±0.02	%/°C
Over temperature Protection	IC built-in		--	--	160	°C
Output short circuit protection			Continuous, self-recovery			
Transient response deviation	Nominal input, 25% load step change		--	55	250	mV
Transient recovery time			--	0.5	1	ms
Thermal impedance			--	85	--	°C/W

Note: * Ripple and noise tested with "parallel cable" method, please see *DC-DC Converter Application Notes* for specific operation methods.

General Specifications

Item	Operating Condition	Min.	Typ.	Max.	Unit
Operating Temperature	Derating if the temperature $\geq 71^\circ\text{C}$ (see Fig. 1)	-40	--	85	°C
Storage Temperature		-55	--	125	
Max. Operating Temperature for casing	Within the operating temperature curve	--	--	100	
Pin Welding Resistance Temperature	Welding spot is 1.5mm away from the casing, 10 seconds	--	--	300	
Storage Humidity	Non-condensing	--	--	95	%RH
Switching Frequency	100% load, input voltage range	280	330	450	KHz
MTBF	MIL-HDBK-217F@25°C	2000	--	--	K hours
Safety-regulated Certification		EN60950			

Physical Specifications

Casing Material	Black flame-retardant and heat-resistant plastic (UL94-V0)
Package Dimensions	11.60*7.55*10.16 mm
Weight	2.00g (Typ.)
Cooling Method	Free air convection

EMC Specifications

EMI	Conducted Disturbance	CISPR22/EN55022	CLASS B (see Fig. 6-② for recommended circuit)	
	Radiated Emission	CISPR22/EN55022	CLASS B (see Fig. 6-② for recommended circuit)	
EMS	Electrostatic Discharge	IEC/EN 61000-4-2	Contact $\pm 4\text{KV}$ perf. Criteria B	
	Radiation Immunity	IEC/EN 61000-4-3	10V/m perf. Criteria A	
	EFT	IEC/EN 61000-4-4	$\pm 1\text{KV}$ (see Fig. 6-① for recommended circuit) perf. Criteria B	
	Surge Immunity	IEC/EN 61000-4-5	$\pm 1\text{KV}$ (see Fig. 6-① for recommended circuit) perf. Criteria B	
	Conducted Disturbance Immunity	IEC/EN 61000-4-6	3Vr.m.s perf. Criteria A	
	Voltage dip, drop and short interruption	IEC/EN 61000-4-29	0%-70% perf. Criteria B	

Product Characteristic Curve

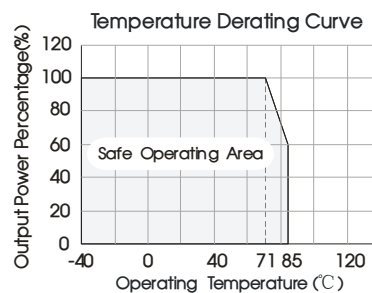
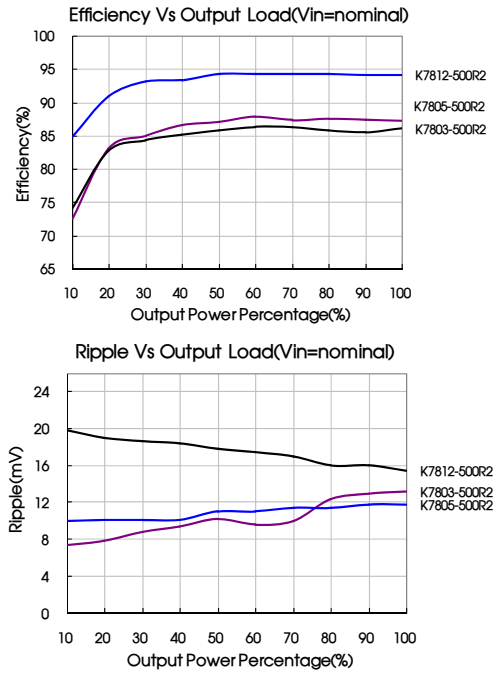
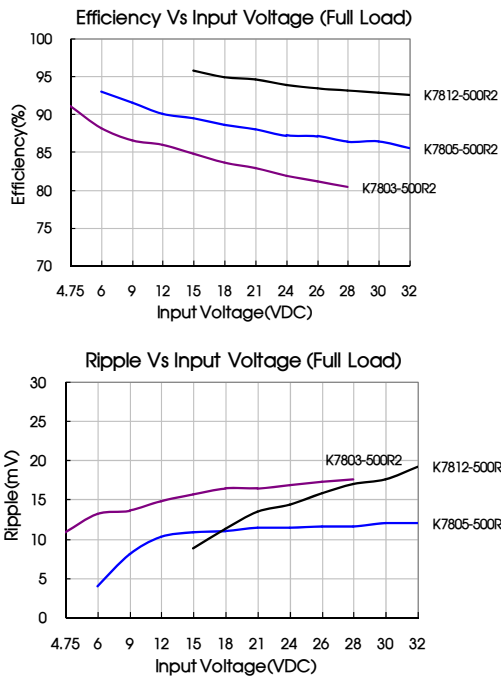
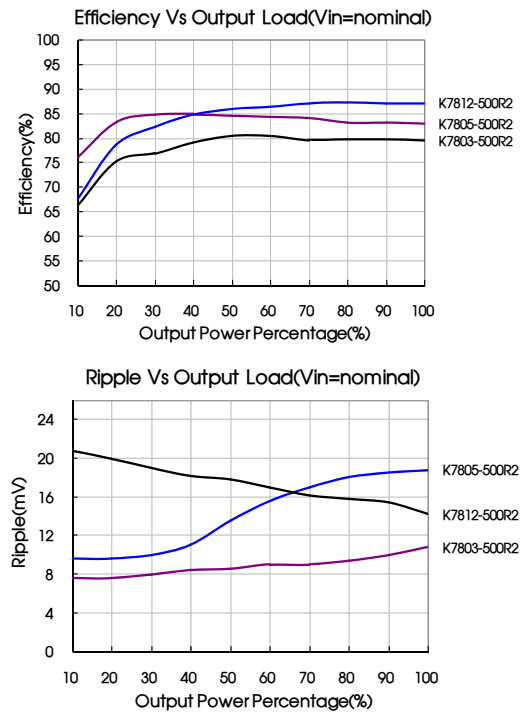
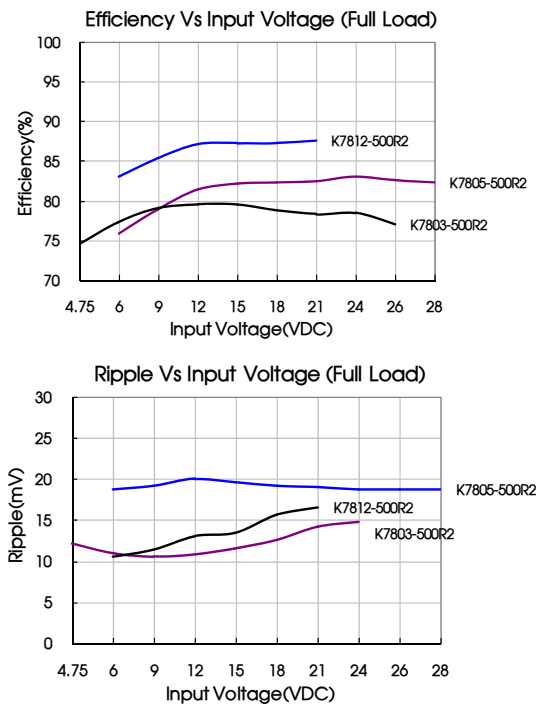

Fig. 1

Positive output character curve



Negative output character curve



Design Reference

1. Typical application circuit

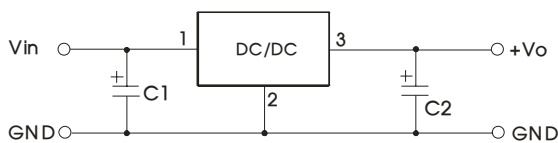

Fig. 2 Positive output application circuit

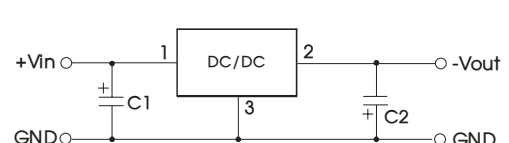

Fig. 3 Negative output application circuit

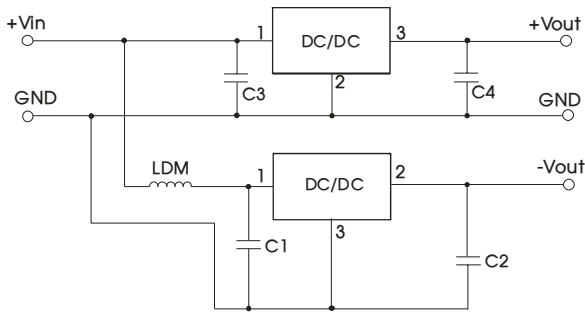

Fig. 4 Positive and Negative output paralleling application circuit

Part No.	C1,C3 (ceramic capacitor)	C2,C4 (ceramic capacitor)
K7801-500R2	10μF/50V	10μF/6.3V
K78X2-500R2		10μF/6.3V
K7802-500R2		10μF/6.3V
K7803-500R2		10μF/6.3V
K7805-500R2		10μF/10V
K78X5-500R2		10μF/10V
K78X6-500R2		10μF/16V
K7809-500R2		10μF/16V
K7812-500R2		10μF/25V
K7815-500R2		10μF/25V

- Note:
- When the products used as negative output and the input-voltage under ($V_{in-min}+2V$), C1 and C2 must be added in the circuit, and they should be placed as near as the products' footprints. Others apply to the application-environment.
 - The capacitance of C1,C2 sees external capacitor table, it can be increased properly if required, and tantalum or low ESR electrolytic capacitors may also suffice.
 - When the products used as the circuit like figure 7, an inductor named as LDM up to 10μH is recommended in the circuit to reduce the mutual interference.
 - For the product of output voltage is below 3.3V or at 3.3V, if the input voltage of model's negative output is less than 4.85V, The output need to add a dummy load of not less than 5mA.
 - Cannot use in parallel for output and hot swap for input.

To reduce the output ripple furtherly, it is suggested to connect a "LC" filter at the output terminal, and recommended value of L is 10μH-47μH.

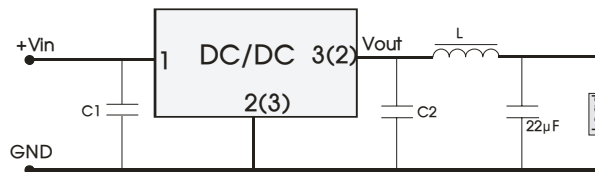

Fig. 5

2. EMC solution-recommended circuit

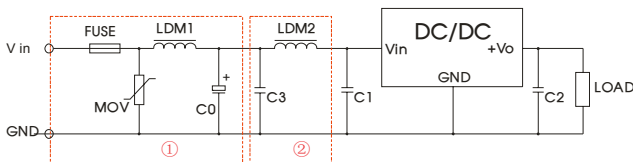

Fig. 6 Recommended EMC circuit

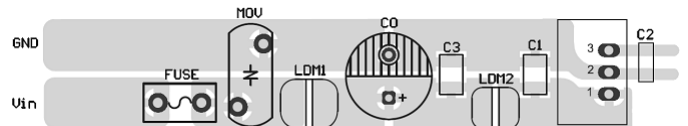

Fig.7 Recommended EMC circuit-PCB layout

FUSE	MOV	LDM1	C0	C1/C2	C3	LDM2
Selected based on the actual input current from the customer	S10K35	82μH	680μF /50V	Refer to Fig.2	4.7μF /50V	12μH

Note: Part ① in the Fig. 1 is for EMS test, part ② is for EMI filtering; parts ① and ② can be added based on actual requirement.

3. Test Configurations (TA=25°C)

1) Efficiency and Output Voltage Ripple Test

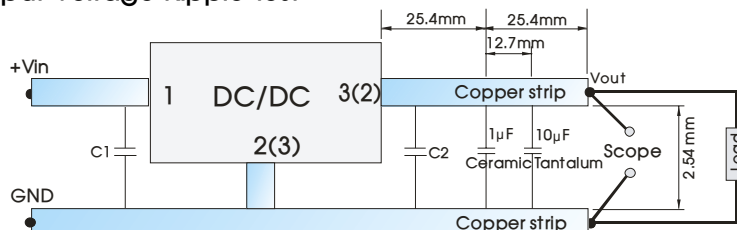

Fig. 8

2) 2.Start-up and Load Transient Response Test

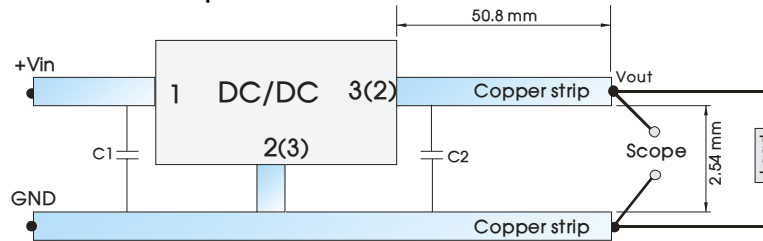
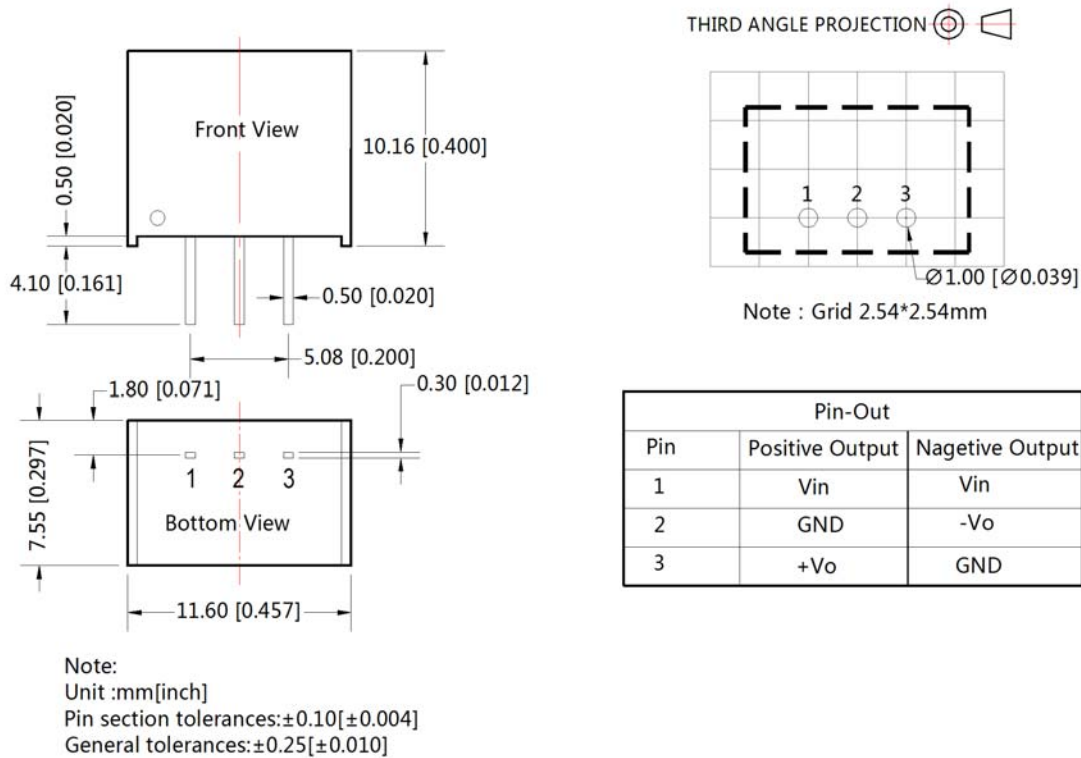

Fig. 9

4. For more information please find the application notes on www.mornsun-power.com

Dimensions and Recommended Layout



Notes:

1. Packing Information please refer to 'Product Packing Information'. Packing bag number: 58200003;
2. The max. capacitive load should be tested within the input voltage range and under full load conditions;
3. Unless otherwise specified, data in this datasheet should be tested under the conditions of Ta=25°C, humidity<75% when inputting nominal voltage and outputting rated load;
4. All index testing methods in this datasheet are based on our Company's corporate standards;
5. The performance indexes of the product models listed in this manual are as above, but some indexes of non-standard model products will exceed the above-mentioned requirements, and please directly contact with our technician for specific information;
6. We can provide product customization service;
7. Specifications of this product are subject to changes without prior notice.

Mornsun Guangzhou Science & Technology Co., Ltd.

Address: No. 5, Kehui St. 1, Kehui Development Center, Science Ave., Guangzhou Science City, Luogang District, Guangzhou, P. R. China
Tel: 86-20-38601850-8801 Fax: 86-20-38601272 E-mail: info@mornsun.cn